

MEDITEC

MEDITEC

YOUR ADVANTAGE

- Modern design and superior surface quality.
- High stability due to reinforcing grid.
- Case design allows easy assembly.
- Designed to eurocard-sizes, double and extended.
- The height can be increased by 50 mm when using the side panels (accessory). For additional heights two panels can be assembled with one connector.
- Wall-mounting brackets for easy, external wall-mounting.
- Stacking elements for secure loading of several devices. Easy fixing by means of the holding devices provided.
- Ergonomic canting position, can also be used for carrying the device. The handle bar can be easily removed at any time. Textured plastic front panel in the same colour as the case, easily removable at any time.
- Textured plastic front panel in the same colour as the case, easy to machine.
- Recessed vertical guide positions for fitting additional mounting plates behind the front panel.
- Side trims are attached laterally, optionally available with / without ventilation.
- The plain case surfaces facilitate easy cleaning and maintenance work.

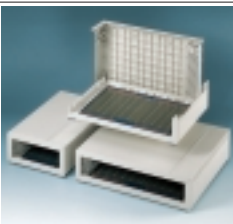

FUNCTION-ORIENTATED.

Another step forward in case design from OKW. This spacious case system will accommodate and enhance high quality electronic systems.

Three sizes with variable heights and ideally suitable for housing equipment of all kinds.

Available in three versions:

- MEDITEC E220 for Eurocards double/normal & extended
- MEDITEC D160 for Eurocards double/normal
- MEDITEC D220 for Eurocards single/normal & extended

APPLICATIONS

Medical field and laboratory technology, feedback control, measuring and control peripherals, modems and interfaces, data collection.



EMC

Cases marked with \neq are available with aluminium metallization on demand. The bonding of base and top shell is mainly performed via the evaporated front panel. See pages 207-209.

MODIFICATIONS AS PER CUSTOMER'S REQUIREMENTS

Machining on modern CNC-controlled machines. Lacquering, Silk screen and tampo printing. See pages 210-213.

STANDARD COLOURS

Case shell, side panels and front panel, off-white, RAL 9002.

Side trims optionally available in off-white, RAL 9002 or lagoon, NCS 1030-B70G.

Slightly textured surface

Please refer to colour chart on page 214.

MATERIAL

Case shells, side panels, front panels and side trims in ABS (UL 94 HB). Also available in other materials on request.

Handle bar:

Side arms and mechanism reinforced Polyamide.

Middle section aluminium profile.

Anti-glide pieces of plastic.

Please refer to the specifications on pages 215-217.

PROTECTION CLASS IP 40

SUPPLY

Optionally available as – complete case consisting of two L-shells, two side trims, case feet and assembly kit

or

– in the form of single case components, paired.

Accessories are separately available.



CONVINCING DESIGN FEATURES.

Innovative combination of case components with L-shell technology and mitre joints.

Identical surface finish on shells as well as on front panels.

Clear, square form with a minimum amount of mould-parting lines. Ideal for machining.

The panels provided with ventilations meet the requirements of protection against accidental contact.

Non-slipping feet in new design and material will not leave any traces.

SIZES

Outside dimensions in mm

MEDITEC	L	W	H
D220	290	260	74
	290	260	124*
D160	290	200	74
	290	200	124*
E220	160	260	74
	160	260	124*

* Case shells combined with 50 mm height side panel (accessory).



SIDE TRIMS

With and without ventilation, easy to fit.

MEDITEC E220 – case dimension ideally suited to accommodate single-Eurocards 100 x 220 mm or 100 x 160 mm

VERSION I

Complete case, side trims with ventilation, colour off-white.

VERSION II

Complete case, side trims with ventilation, colour lagoon.

VERSION III

Complete case, side trims without ventilation, colour off-white.

VERSION IV

Complete case, side trims without ventilation, colour lagoon.

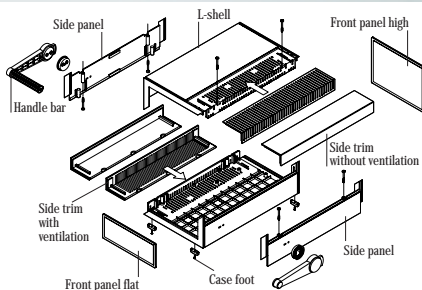
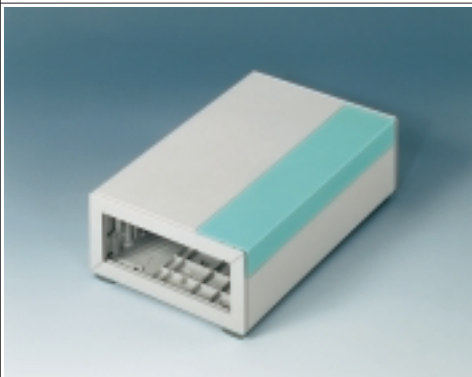

DESIGN

L-shell technology. Two identical shells are joined together so that they overlap. The grid provides a high amount of stability. The side trims are attached laterally and keep their position independently; optionally available with / without ventilation.

Non-slip case feet are fixed by screws to ensure a firm and stable support.

Fastening towers have been positioned for mounting Eurocards. Injection moulded front panels (accessory) in case colour, easy to machine. Recessed, vertical guides for further assembly or installation of front panels. The height can be increased by 50 mm when using the side panels (accessory).

Separate handle bar can be assembled externally (assembly instruction for the handle see our website www.okw.com).

Separate handle bar can be assembled externally (assembly instruction for the handle see our website www.okw.com).

ORDER DETAILS COMPLETE CASE

Part-No.	MEDITEC	Outside dimensions in mm			Supply L-shells	Side trims	Assembly kit + Feet
		L	W	H			
B 22 12 007 #	E220, Version I	160	260	74	2 pcs., off-white	2 pcs., with ventilation, off-white	included
B 22 12 005 #	E220, Version II	160	260	74	2 pcs., off-white	2 pcs., with ventilation, lagoon	included
B 22 12 017 #	E220, Version III	160	260	74	2 pcs., off-white	2 pcs., without ventilation, off-white	included
B 22 12 015 #	E220, Version IV	160	260	74	2 pcs., off-white	2 pcs., without ventilation, lagoon	included

ORDER DETAILS FOR KITS (for individual combination with intermediate parts)

MEDITEC	Article	Supply
B 20 12 007 #	E220	L-shells without holes
B 20 12 107 #	E220	L-shells with holes for handle bar
B 20 20 007	E220	Side trims 220
B 20 20 005		2 pieces, without ventilation, off-white
B 20 21 007		2 pieces, without ventilation, lagoon
B 20 21 005		2 pieces, with ventilation, off-white
		2 pieces, with ventilation, lagoon

ORDER DETAILS ACCESSORIES (stacking elements + wall-mounting brackets see page 142)

for MEDITEC...	Article	Version / Supply
B 20 30 007 #	E220	Side panels 220 without holes
B 20 30 107 #	E220	Side panels 220 with holes for handle bar
B 21 16 307 #	E220	Front panel E flat
B 21 16 407 #	E220	Front panel E high
B 21 16 507	E220	Handle bar E
A 91 99 008	E220	Set of screws

Detailed drawing available on demand in dwg or dxf format.

⊕ = Type of screw for case fixing; cross head

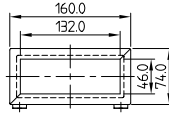
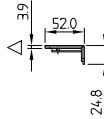
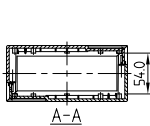

Case combination with two side panels (acc.)

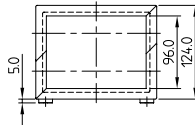
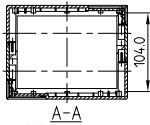

L-shell

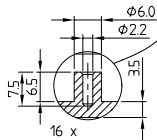
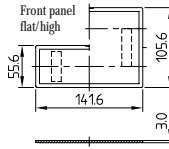
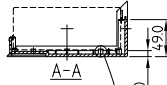

Top view L-shell

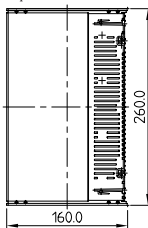

Side trim with ventilation



Side trim without ventilation



Inside view L-shell

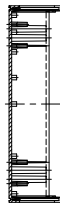
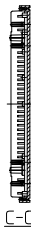
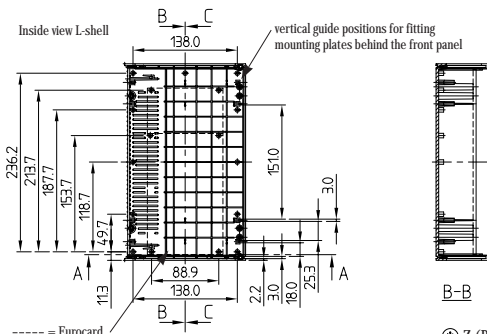

--- = Eurocard

⊕ Z (PZ2)



MEDITEC E220 Version I, side trims with ventilation, colour off-white.



MEDITEC E220 Version II, side trims with ventilation, colour lagoon.



MEDITEC E220 Version III, side trims without ventilation, colour off-white.



MEDITEC E220 Version IV, side trims without ventilation, colour lagoon.

MEDITEC

MEDITEC

MEDITEC D160 – case dimension ideally suited to accommodate double-Eurocards 233.4 x 160 mm.

VERSION I

Complete case, side trims with ventilation, colour off-white.

VERSION II

Complete case, side trims with ventilation, colour lagoon.

VERSION III

Complete case, side trims without ventilation, colour off-white.

VERSION IV

Complete case, side trims without ventilation, colour lagoon.

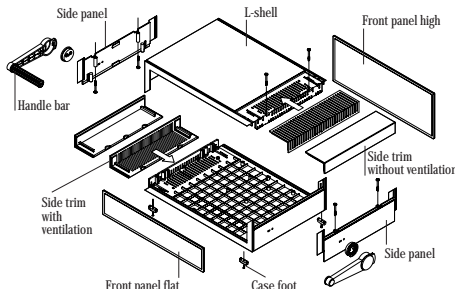
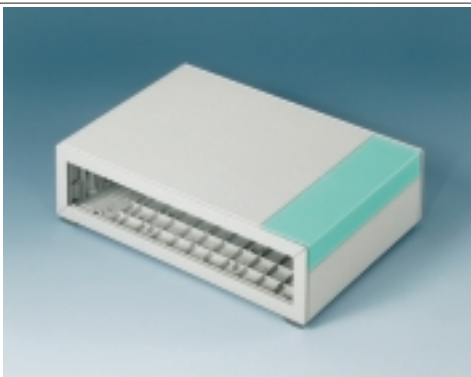

DESIGN

L-shell technology. Two identical shells are joined together so that they overlap. The grid provides a high amount of stability. The side trims are attached laterally and keep their position independently; optionally available with or without ventilation. Non-slip case feet are fixed by screws to ensure a firm and stable support. Fastening towers have been positioned for mounting Eurocards. Injection moulded front panels (accessory) in case colour, easy to machine. Recessed, vertical guides for further assembly or installation of front panels. The height can be increased by 50 mm when using the side panels (accessory). Separate handle bar can be assembled externally (assembly instruction for the handle see our website www.okw.com).

Part No.

ORDER DETAILS COMPLETE CASE

MEDITEC	Outside dimensions in mm			Supply L-shells	Side trims	Assembly kit + Feet	
	L	W	H				
B 22 11 007 #	D160, Version I	290	200	74	2 pcs., off-white	2 pcs., with ventilation, off-white	included
B 22 11 005 #	D160, Version II	290	200	74	2 pcs., off-white	2 pcs., with ventilation, lagoon	included
B 22 11 017 #	D160, Version III	290	200	74	2 pcs., off-white	2 pcs., without ventilation, off-white	included
B 22 11 015 #	D160, Version IV	290	200	74	2 pcs., off-white	2 pcs., without ventilation, lagoon	included

ORDER DETAILS FOR KITS (for individual combination with side panels)

MEDITEC	Article	Supply
B 20 11 007 #	D160 L-shells without holes	2 pieces, off-white, 290 x 200 x 74 mm, including assembly kit + 4 case feet
B 20 11 107 #	D160 L-shells with holes for handle bar	2 pieces, off-white, 290 x 200 x 74 mm, including assembly kit + 4 case feet
B 20 22 007	D160 Side trims 160	2 pieces, without ventilation, off-white
B 20 22 005		2 pieces, without ventilation, lagoon
B 20 23 007		2 pieces, with ventilation, off-white
B 20 23 005		2 pieces, with ventilation, lagoon

ORDER DETAILS ACCESSORIES (stacking elements + wall-mounting brackets see page 142)

for MEDITEC...	Article	Version / Supply
B 20 31 007 #	D160 Side panels 160 without holes	for 50 mm additional height, off-white, 2 pieces with set of screws
B 20 31 107 #	D160 Side panels 160 with holes for handle bar	for 50 mm additional height, off-white, 2 pieces with set of screws
B 21 29 307 #	D160 Front panel D flat	for case without side panels, moulded, off-white, 1 piece
B 21 29 407 #	D160 Front panel D high	for case with two side panels, moulded, off-white, 1 piece
B 21 29 507	D160 Handle bar D	Side trims off-white, push buttons volcano, aluminium profile, 1 piece
A 91 99 008	D160 Set of screws	for mounting PCBs, ø 2.5 mm x 6 mm, 4 screws per set

Detailed drawing available on demand in dwg or dxf format.

⊕ ⊗ = Type of screw for case fixing; cross head

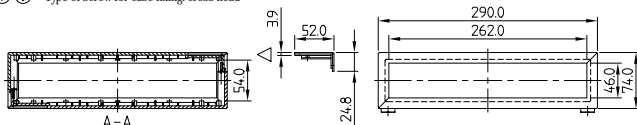

A-A

Case combination with two side panels (acc.)

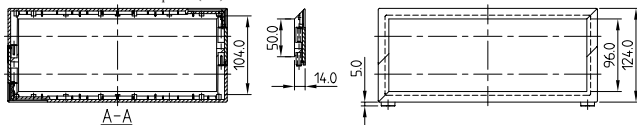

A-A

L-shell

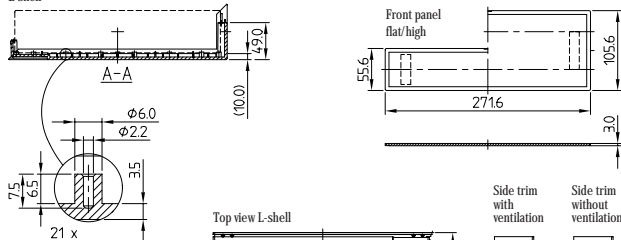

A-A

21 x

Top view L-shell

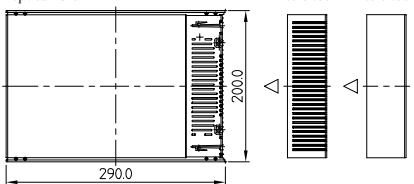

Inside view L-shell

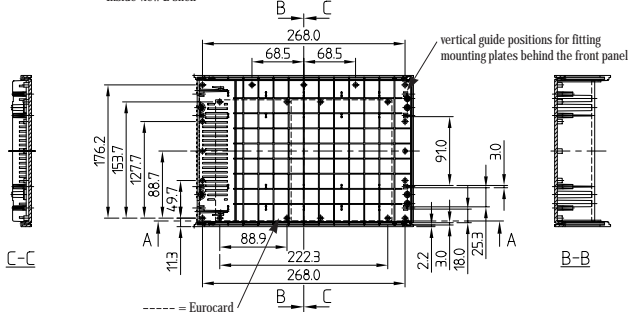

C-C

B-B

--- = Eurocard

⊕ Z (PZ2)



MEDITEC D160 Version I, side trims with ventilation colour off-white.



MEDITEC D160 Version II, side trims with ventilation colour lagoon.



MEDITEC D160 Version III, side trims without ventilation, colour off-white.



MEDITEC D160 Version IV, side trims without ventilation, colour lagoon.

MEDITEC D220 – case dimension ideally suited to accommodate double-Eurocards 233.4 x 220 mm.

VERSION I

Complete case, side trims with ventilation, colour off-white.

VERSION II

Complete case, side trims with ventilation, colour lagoon.

VERSION III

Complete case, side trims without ventilation, colour off-white.

VERSION IV

Complete case, side trims with ventilation, colour lagoon.

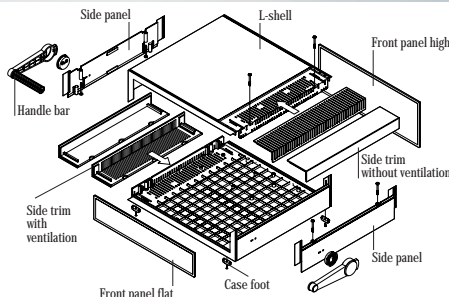
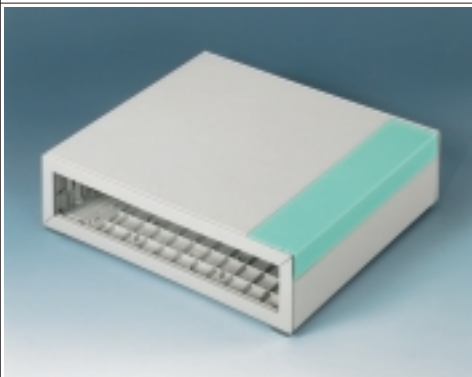

DESIGN

L-shell technology. Two identical shells are joined together so that they overlap. The grid provides a high amount of stability. The side trims are attached laterally and keep their position independently; optionally available with or without ventilation. Non-slipping case feet are fixed by screws to ensure a firm and stable support. Fastening towers have been positioned for mounting Eurocards. Injection moulded front panels (accessory) in case colour, easy to machine. Recessed, vertical guides for further assembly or installation of front panels. The height can be increased by 50 mm when using the side panels (accessory). Separate handle bar can be assembled externally (assembly instruction for the handle see our website www.okw.com).

Part-No.

ORDER DETAILS COMPLETE CASE

MEDITEC	Outside dimensions in mm	Supply L-shells	Side trims	Assembly kit + Feet	
					L
B 22 10 007 #	D220, Version I	290 260 74	2 pcs., off-white	2 pcs., with ventilation, off-white	included
B 22 10 005 #	D220, Version II	290 260 74	2 pcs., off-white	2 pcs., with ventilation, lagoon	included
B 22 10 017 #	D220, Version III	290 260 74	2 pcs., off-white	2 pcs., without ventilation, off-white	included
B 22 10 015 #	D220, Version IV	290 260 74	2 pcs., off-white	2 pcs., without ventilation, lagoon	included

ORDER DETAILS FOR KITS (for individual combination with side panels)

MEDITEC	Article	Supply
B 20 10 007 #	D220	L-shells without holes
B 20 10 107 #	D220	L-shells with holes for handle bar
B 20 20 007 #	D220	Side trims 220
B 20 20 005 #		2 pieces, without ventilation, off-white
B 20 21 007 #		2 pieces, without ventilation, lagoon
B 20 21 005 #		2 pieces, with ventilation, off-white
		2 pieces, with ventilation, lagoon

ORDER DETAILS ACCESSORIES (Stacking elements + wall-mounting brackets see page 142)

for MEDITEC...	Article	Version / Supply
B 20 30 007 #	D220	Side panels 220 without holes
B 20 30 107 #	D220	Side panels 220 with holes for handle bar
B 21 29 307 #	D220	Front panel D flat
B 21 29 407 #	D220	Front panel D high
B 21 29 507 #	D220	Handle bar D
A 91 99 008	D220	Set of screws

Detailed drawing available on demand in dwg or dxf format.

⊕ ⊕ = Type of screw for case fixing; cross head

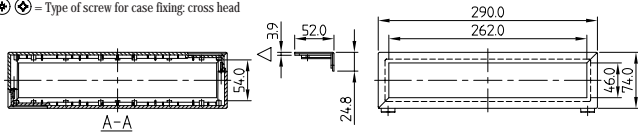

Case combination with two side panels (acc.)

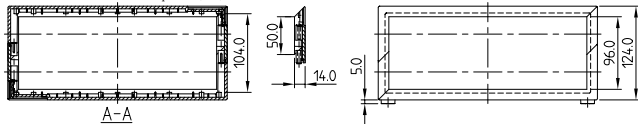

L-shell

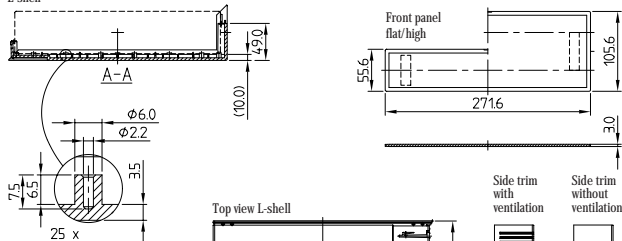

Top view L-shell

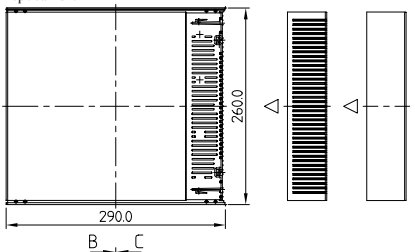

Inside view L-shell

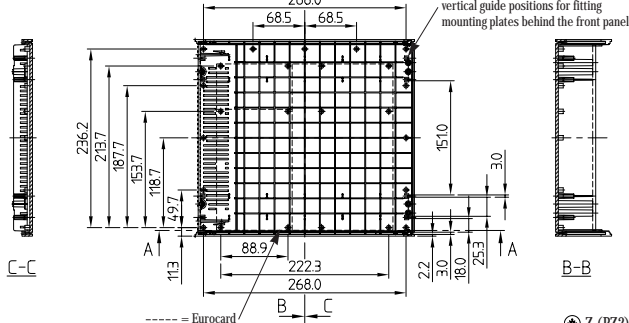

⊕ Z (PZ2)



MEDITEC D220 Version I, side trims with ventilation, colour off-white.

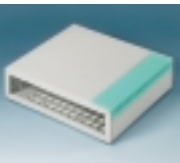

MEDITEC D220 Version II, side trims with ventilation, colour lagoon.



MEDITEC D220 Version III, side trims without ventilation, colour off-white.

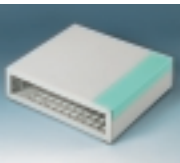

MEDITEC D220 Version IV, side trims without ventilation, colour lagoon.

WALL-MOUNTING BRACKETS

For easy wall-mounting.

Supply:
4 pieces.
Fastening screws.

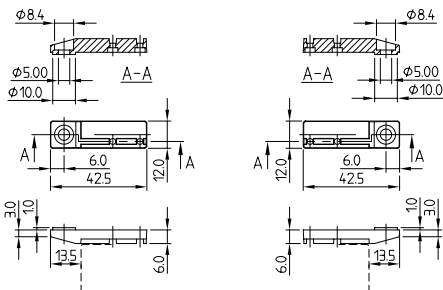

Part-No.

B 21 33 012

Article / Version

Wall-mounting brackets, PA, volcano

STACKING ELEMENTS

For secure stacking of several devices. Easy fixing using the holding devices provided.

Supply:
4 stacking elements.

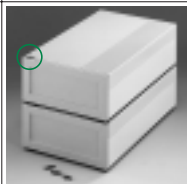
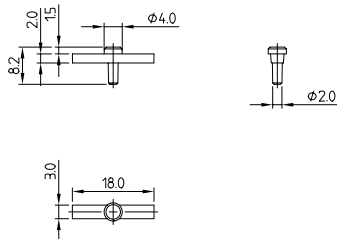

Part-No.

B 21 34 012

Article / Version

Stacking elements, volcano

CONNECTOR

For secure connection of 2 side panels. Screwless assembly, simply pin and lock. 1 set with 4 separate parts needed for each case.

Supply:
4 connectors.

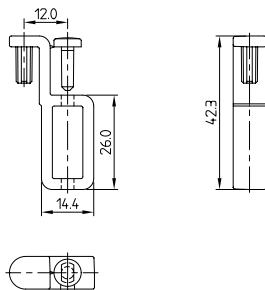

Part-No.

B 21 35 017

Article / Version

Connector, ABS, off-white