

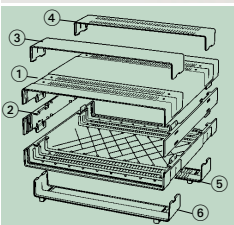

Subject to technical modification without notice. Typographical and other errors do not justify any claim for damages.
Stand: 11/99 e Copyright © 1999 OKW Gehäusesysteme KG, Buchen, Germany (<http://www.okw.com>)

YOUR
ADVANTAGE

- Quick and easy assembly. The EURO CASE has a modular construction that is assembled without the use of screws.
- Injection-moulded reinforcing ribs ensure that these conveniently light cases are provided with a high degree of torsional resistance and rigidity.
- Side panels in three sizes for optional arrangements allow vertical assemblies in combination to be stacked together – depending on the space your electronic components need.
- Any problems in ventilation are solved by snap-in panels with ventilation slots. These panels can be mounted instead of the closed panels.
- Ergonomically convenient canting by tilt feet or robust handle, which is also applicable for transport.



APPLICATIONS

Excellent range of housings for all fields of electronics, e.g. peripheral equipment for computers, floppy disks, medical devices etc. Measuring and control logging.

- ① Case shell
- ② Side panel
- ③ Snap-in panel without ventilation
- ④ Snap-in panel with ventilation
- ⑤ Snap-in panel with ventilation, with feet
- ⑥ Snap-in panel without ventilation, with feet

EMC

Cases marked with Σ are available with aluminium metallization on demand. The bonding of base and top shell is mainly performed via the evaporated front panel. See pages 207-209.

STANDARD
COLOURS

Case shells with side panels, snap-in panels and handle as one-coloured assembly in off-white, RAL 9002.

Side panels, handle and tilt feet pebble grey, RAL 7032 coloured for alternative combinations. See also order data of accessories. Please refer to colour chart on page 214.

MATERIAL

ABS (UL 94 HB). Also available in other materials on request. Please refer to the specifications on pages 215-217.

RATIONAL, VERSATILE, MOBILE WITH HANDLE BAR

The EURO CASE has a modular construction that is assembled without the use of screws. The top and base shells, side panels and snap-in panels all have a strong clip together mechanism which can be dismantled using the special key provided.

It is possible to customize the EURO CASE to your own look by having the side panels and snap-in covers either moulded or painted in your own colours.

The EURO CASES are each available in three basic dimensions and in different heights.

MODIFICATIONS
AS PER
CUSTOMER'S
REQUIREMENTS

Machining on modern CNC-controlled machines. Lacquering. Silk screen and tamper printing. See pages 210-213.

VARIOUS CASE HEIGHTS

42 TE, 63 TE



1 HE



1,5 HE



2 HE

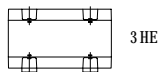

3 HE

84 TE



2 HE

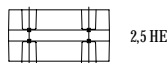

2,5 HE



3 HE

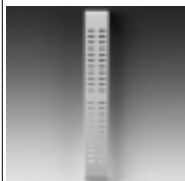

Any problems in ventilation are solved by snap-in panels with ventilation slots. These panels can either be mounted in the upper or the lower case shell, at front or rear.



EURO CASE
42 TE, 2 HE

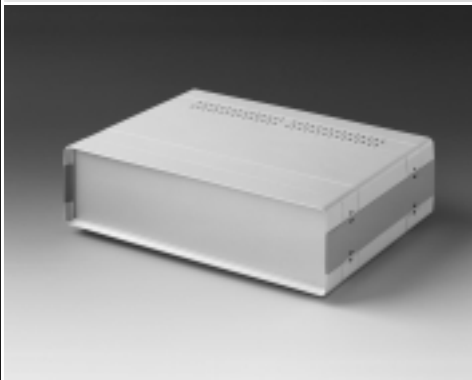

EURO CASE
63 TE, 2 HE



EURO CASE
84 TE, 2 HE

Detailed drawing available on demand in dwg or dxf format.

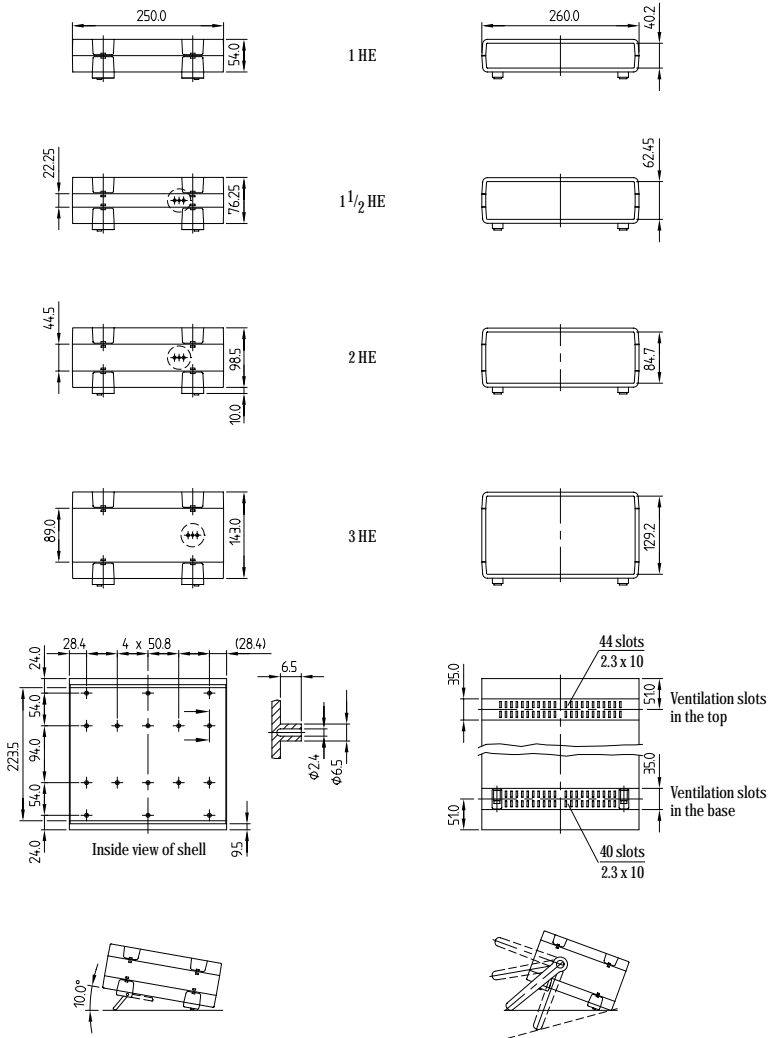

ORDER DATA FOR EURO CASE 42 TE COMPLETE

Version			Supply										Part-No.	
Height-unit	Ventilation	Colour combination	Shell 42 TE	Side panels		1 HE for handle		2 HE for handle		Snap-in panels		Handle	Complete case	
				1 HE	2 HE			without slots	with slots	without slots with feet	with slots with feet		without handle	with handle
1	<input type="checkbox"/>	off-white	2	-	-	-	-	2	-	2	-	-	A 02 14 070	-
1	<input type="checkbox"/>	off-white	2	-	-	-	-	1	1	1	1	-	A 02 14 170	-
1	<input type="checkbox"/>	off-white	2	-	-	-	-	-	2	-	2	-	A 02 14 270	-
2	<input type="checkbox"/>	off-white	2	2	-	-	-	2	-	2	-	-	A 02 24 070	-
2	<input type="checkbox"/>	off-white	2	-	-	2	-	2	-	2	-	1	-	A 02 24 470
2	<input type="checkbox"/>	off-white	2	2	-	-	-	1	1	1	1	-	A 02 24 170	-
2	<input type="checkbox"/>	off-white	2	-	-	2	-	1	1	1	1	1	-	A 02 24 570
2	<input type="checkbox"/>	off-white	2	2	-	-	-	-	2	-	2	-	A 02 24 270	-
2	<input type="checkbox"/>	off-white	2	-	-	2	-	-	2	-	2	1	-	A 02 24 670
3	<input type="checkbox"/>	off-white	2	-	2	-	-	2	-	2	-	-	A 02 34 070	-
3	<input type="checkbox"/>	off-white	2	-	-	-	2	2	-	2	-	1	-	A 02 34 470
3	<input type="checkbox"/>	off-white	2	-	2	-	-	1	1	1	1	-	A 02 34 170	-
3	<input type="checkbox"/>	off-white	2	-	-	-	2	1	1	1	1	1	-	A 02 34 570
3	<input type="checkbox"/>	off-white	2	-	2	-	-	-	2	-	2	-	A 02 34 270	-
3	<input type="checkbox"/>	off-white	2	-	-	-	2	-	2	-	2	1	-	A 02 34 670

ORDER DATA PIECE PARTS	Colours:		Colour combination:		
	off-white	pebble grey	off-white	pebble grey / push-button off-white	off-white / push-button pebble grey
Shell 42 TE	A 01 14 170 ‡				
Side panel 0.5 HE	A 01 05 270 ‡	A 01 05 280 ‡			
Side panel 1 HE	A 01 10 270 ‡	A 01 10 280 ‡			
Side panel 2 HE	A 01 20 270 ‡	A 01 20 280 ‡			
Side panel 0.5 HE for handle mounting	A 01 06 270 ‡	A 01 06 280 ‡			
Side panel 1 HE for handle mounting	A 01 11 270 ‡	A 01 11 280 ‡			
Side panel 2 HE for handle mounting	A 01 21 270 ‡	A 01 21 280 ‡			
Snap-in panel without slots	A 01 14 370				
Snap-in panel with slots	A 01 24 370				
Snap-in panel without slots, with feet	A 01 34 370				
Snap-in panel with slots, with feet	A 01 44 370				
Handle			A 03 44 217	A 03 44 218	A 03 44 216
Tilt foot	A 03 50 007				

TO ACHIEVE ONE EURO CASE FROM PIECE PARTS, FOR A SPECIAL COMBINATION, ORDER:

- 2 Case shells
- 2 Side panels (if needed)
- 4 Snap-in panels
- 1 Handle (if needed)
- 2 Tilt feet (if needed)

VERSION VENTILATION COMPLETE CASES

- = Version without ventilation slots
- = Version with ventilation slots at rear, top and base
- = Version with ventilation slots at front, rear, top and base

Detailed drawing available on demand in dwg or dxf format.

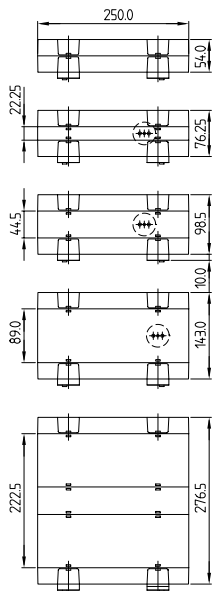

1 HE

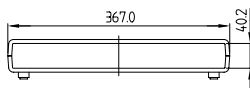

1 1/2 HE

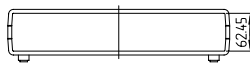

2 HE

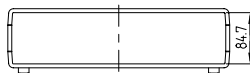

3 HE

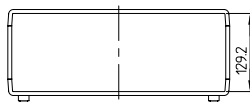

6 HE

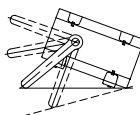
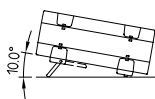
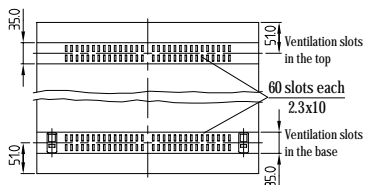
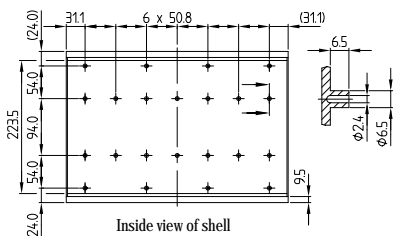
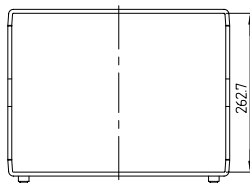

ORDER DATA FOR EURO CASE 63 TE COMPLETE

Version			Supply									Part-No.		
Height-unit	Ventilation	Colour combination	Shell 63 TE	Side panels		1 HE for handle		2 HE for handle		Snap-in panels		Handle	Complete case	
				1 HE	2 HE	without slots	with slots	without slots with feet	with slots with feet	without handle	with handle			
1	<input type="checkbox"/>	off-white	2	-	-	-	-	2	-	2	-	-	A 02 16 070	-
1	<input type="checkbox"/>	off-white	2	-	-	-	-	1	1	1	1	-	A 02 16 170	-
1	<input type="checkbox"/>	off-white	2	-	-	-	-	-	2	-	2	-	A 02 16 270	-
2	<input type="checkbox"/>	off-white	2	2	-	-	-	2	-	2	-	-	A 02 26 070	-
2	<input type="checkbox"/>	off-white	2	-	-	2	-	2	-	2	-	1	-	A 02 26 470
2	<input type="checkbox"/>	off-white	2	2	-	-	-	1	1	1	1	-	A 02 26 170	-
2	<input type="checkbox"/>	off-white	2	-	-	2	-	1	1	1	1	1	-	A 02 26 570
2	<input type="checkbox"/>	off-white	2	2	-	-	-	-	2	-	2	-	A 02 26 270	-
2	<input type="checkbox"/>	off-white	2	-	-	2	-	-	2	-	2	1	-	A 02 26 670
3	<input type="checkbox"/>	off-white	2	-	2	-	-	2	-	2	-	-	A 02 36 070	-
3	<input type="checkbox"/>	off-white	2	-	-	-	2	2	-	2	-	1	-	A 02 36 470
3	<input type="checkbox"/>	off-white	2	-	2	-	-	1	1	1	1	-	A 02 36 170	-
3	<input type="checkbox"/>	off-white	2	-	-	-	2	1	1	1	1	1	-	A 02 36 570
3	<input type="checkbox"/>	off-white	2	-	2	-	-	-	2	-	2	-	A 02 36 270	-
3	<input type="checkbox"/>	off-white	2	-	-	-	2	-	2	-	2	1	-	A 02 36 670
6	<input type="checkbox"/>	off-white	2	2	4	-	-	2	-	2	-	-	A 02 66 070	-
6	<input type="checkbox"/>	off-white	2	2	4	-	-	1	1	1	1	-	A 02 66 170	-
6	<input type="checkbox"/>	off-white	2	2	4	-	-	-	2	-	2	-	A 02 66 270	-

ORDER DATA PIECE PARTS

	Colours:		Colour combination:		
	off-white	pebble grey	off-white	pebble grey / push-button off-white	off-white / push-button pebble grey
Shell 63 TE	A 01 16 170 ‡				
Side panel 0.5 HE	A 01 05 270 ‡	A 01 05 280 ‡			
Side panel 1 HE	A 01 10 270 ‡	A 01 10 280 ‡			
Side panel 2 HE	A 01 20 270 ‡	A 01 20 280 ‡			
Side panel 0.5 HE for handle mounting	A 01 06 270 ‡	A 01 06 280 ‡			
Side panel 1 HE for handle mounting	A 01 11 270 ‡	A 01 11 280 ‡			
Side panel 2 HE for handle mounting	A 01 21 270 ‡	A 01 21 280 ‡			
Snap-in panel without slots	A 01 16 370				
Snap-in panel with slot	A 01 26 370				
Snap-in panel without slots, with feet	A 01 36 370				
Snap-in panel with slots, with feet	A 01 46 370				
Handle			A 03 46 317	A 03 46 318	A 03 46 316
Tilt foot	A 03 50 007				

TO ACHIEVE ONE EURO CASE FROM PIECE PARTS, FOR A SPECIAL COMBINATION, ORDER:

- 2 Case shells
- 2 Side panels (if needed)
- 4 Snap-in panels
- 1 Handle (if needed)
- 2 Tilt feet (if needed)

VERSION VENTILATION COMPLETE CASES

- = Version without ventilation slots
- = Version with ventilation slots at rear, top and base
- = Version with ventilation slots at front, rear, top and base

Detailed drawing available on demand in dwg or dxf format.

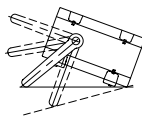
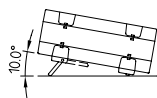
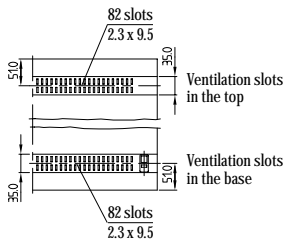
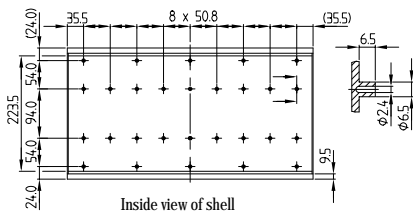
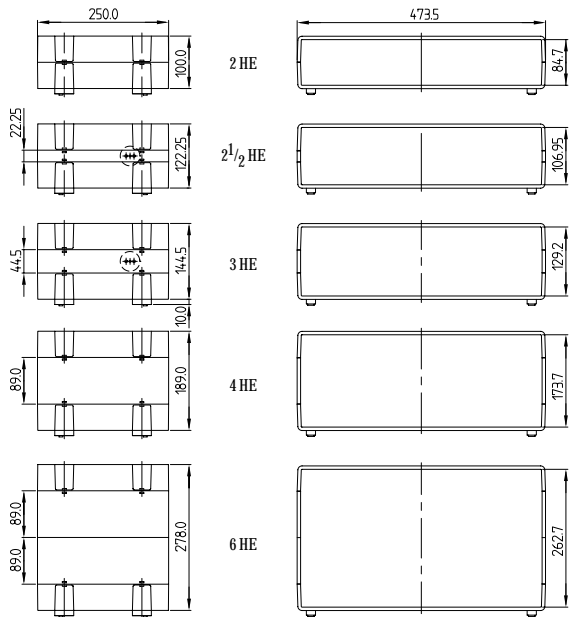

ORDER DATA FOR EURO CASE 84 TE COMPLETE

Version			Supply										Part-No.	
Height-unit	Ventilation	Colour combination	Shell 84 TE	Side panels		1 HE for handle		2 HE for handle		Snap-in panels		Handle	Complete case	
				1 HE	2 HE	without slots	with slots	without slots with feet	with slots with feet	without handle	with handle			
2	<input type="checkbox"/>	off-white	2	-	-	-	-	2	-	2	-	-	A 02 28 070	-
2	<input type="checkbox"/>	off-white	2	-	-	-	-	1	1	1	1	-	A 02 28 170	-
2	<input type="checkbox"/>	off-white	2	-	-	-	-	-	2	-	2	-	A 02 28 270	-
3	<input type="checkbox"/>	off-white	2	2	-	-	-	2	-	2	-	-	A 02 38 070	-
3	<input type="checkbox"/>	off-white	2	-	-	2	-	2	-	2	-	1	-	A 02 38 470
3	<input type="checkbox"/>	off-white	2	2	-	-	-	1	1	1	1	-	A 02 38 170	-
3	<input type="checkbox"/>	off-white	2	-	-	2	-	1	1	1	1	1	-	A 02 38 570
3	<input type="checkbox"/>	off-white	2	2	-	-	-	2	-	2	-	-	A 02 38 270	-
3	<input type="checkbox"/>	off-white	2	-	-	2	-	-	2	-	2	1	-	A 02 38 670
4	<input type="checkbox"/>	off-white	2	-	2	-	-	2	-	2	-	-	A 02 48 070	-
4	<input type="checkbox"/>	off-white	2	-	-	-	2	2	-	2	-	1	-	A 02 48 470
4	<input type="checkbox"/>	off-white	2	-	2	-	-	1	1	1	1	-	A 02 48 170	-
4	<input type="checkbox"/>	off-white	2	-	-	-	2	1	1	1	1	1	-	A 02 48 570
4	<input type="checkbox"/>	off-white	2	-	2	-	-	-	2	-	2	-	A 02 48 270	-
4	<input type="checkbox"/>	off-white	2	-	-	-	2	-	2	-	2	1	-	A 02 48 670
6	<input type="checkbox"/>	off-white	2	-	4	-	-	2	-	2	-	-	A 02 68 070	-
6	<input type="checkbox"/>	off-white	2	-	4	-	-	1	1	1	1	-	A 02 68 170	-
6	<input type="checkbox"/>	off-white	2	-	4	-	-	-	2	-	2	-	A 02 68 270	-

ORDER DATA PIECE PARTS

	Colours:		Colour combination:		
	off-white	pebble grey	off-white	pebble grey / push-button off-white	off-white / push-button off-white
Shell 84 TE	A 01 28 170				
Side panel 0.5 HE	A 01 05 270	A 01 05 280			
Side panel 1 HE	A 01 10 270	A 01 10 280			
Side panel 2 HE	A 01 20 270	A 01 20 280			
Side panel 0.5 HE for handle mounting	A 01 06 270	A 01 06 280			
Side panel 1 HE for handle mounting	A 01 11 270	A 01 11 280			
Side panel 2 HE for handle mounting	A 01 21 270	A 01 21 280			
Snap-in panel without slots	A 01 18 370				
Snap-in panel with slots	A 01 28 370				
Snap-in panel without slots, with feet	A 01 38 370				
Snap-in panel with slots, with feet	A 01 48 370				
Handle			A 03 48 417	A 03 48 418	A 03 48 416
Tilt foot	A 03 50 007				

TO ACHIEVE ONE EURO CASE FROM PIECE PARTS, FOR A SPECIAL COMBINATION, ORDER:

- 2 Case shells
- 2 Side panels (if needed)
- 4 Snap-in panels
- 1 Handle (if needed)
- 2 Tilt foot (if needed)

VERSION VENTILATION COMPLETE CASES

- = Version without ventilation slots
- = Version with ventilation slots at rear, top and base
- = Version with ventilation slots at front, rear, top and base

TILT FOOT

Supply:
1 tilt foot.
(order 2 per case)

Part-No.

A 03 50 007

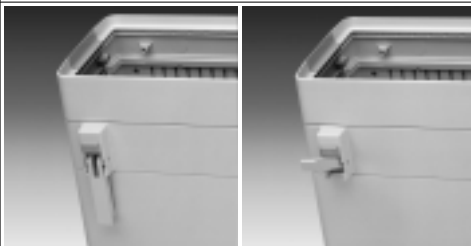

Version

ABS, off-white RAL 9002

APPLICATION

The tilt foot is used for canting the unit and is suitable for combination with snap-in panels with rubber feet. It simply snaps into the feet section and can be folded flatly.

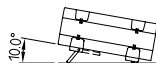

HANDLE BAR

Side arms and mechanism
glass-reinforced polyamide.

Supply:
2 side arms.
1 aluminium section.
2 fastening screws.

Part-No.

A 03 44 217

A 03 46 317

A 03 48 417

A 03 44 218

A 03 46 318

A 03 48 418

A 03 44 216

A 03 46 316

A 03 48 416

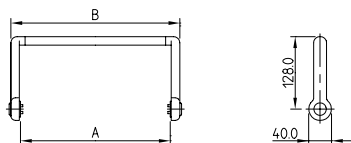

Width TE	Dim. in mm		Colour combination
	A	B	
42	260	294	off-white
63	367	401	off-white
84	473	507	off-white
42	260	294	pebble grey, push buttons off-white
63	367	401	pebble grey, push buttons off-white
84	473	507	pebble grey, push buttons off-white
42	260	294	off-white, push buttons pebble-grey
63	367	401	off-white, push buttons pebble-grey
84	473	507	off-white, push buttons pebble-grey



APPLICATION

For canting and carrying the unit. Strong ratchet with 30° indexing.

Load capacity:
At 0° angle 400 N.
At 30° angle 200 N.
At 60° angle 350 N.
At 90° angle 400 N.

FRONT- AND REAR PANELS

Of anodized aluminium,
thickness 2 mm.

Part-No.

A 03 14 270

A 03 54 270

A 03 24 270

A 03 34 270

A 03 16 370

A 03 26 370

A 03 36 370

A 03 66 370

A 03 28 470

A 03 38 470

A 03 48 470

A 03 68 470

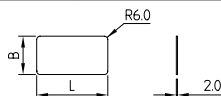

For Case	Dim. in mm	
	L	B
42 TE 1 HE	250.8	46.3
42 TE 1.5 HE	250.8	68.5
42 TE 2 HE	250.8	90.7
42 TE 3 HE	250.8	135.2
63 TE 1 HE	357.8	46.3
63 TE 2 HE	357.8	90.7
63 TE 3 HE	357.8	135.2
63 TE 6 HE	357.8	268.6
84 TE 2 HE	464.3	90.5
84 TE 3 HE	464.3	135.0
84 TE 4 HE	464.3	179.3
84 TE 6 HE	464.3	268.1

Front- and rear panels for case combinations with 0.5 HE side panels on demand.

Supply:
1 piece.